

2016

VIETNAM
ELECTRICITY
ANNUAL
REPORT



EVN





Contents

Message from the Chairman	2
Message from the President & CEO	4
Organization Chart	6
Vietnam Electricity Profile	8
Power Generation	10
Power Transmission and Distribution Networks	14
Performance Highlights	16
Power Business and Services	20
Consolidated Financial Statements	24
International Cooperation and Investment Opportunities	26
Investment Projects	28
Renewable Energy Development and Environmental Protection	32
Power Market Development	34
Training and Human Resource Development	36
Member Companies	38
Geographical Scheme of Vietnam Power System	40



Message from the Chairman

*The motto chosen
for the year 2016
“Strengthening
Institution and
Administration
within EVN”*

In 2015, despite many difficulties, under the leadership of the Party, the visionary guidance from the Government and the efforts of ministries and Governmental agencies at all levels, the national economy has gradually recovered and thrived with an increase in gross domestic product of 6.68% compared to 2014. Contributing to these remarkable achievements, the power sector of Vietnam, with Vietnam Electricity (EVN) playing the crucial driving role, was appreciated for its significant dedication.

Moving towards the 13th National Congress of the Communist Party of Vietnam, on the 61st anniversary of Vietnam Revolutionary Power Sector (December 21st, 1954 -

December 21st, 2015), more than 100,000 employees of EVN have promoted creativeness and devotion to fulfill assigned tasks. Thanks to these great efforts, EVN ensured sufficient power supply for national economy and society with a 11.7% power sales growth.

By the end of 2015, Vietnam power system was ranked the 2nd in the ASEAN and 30th in the world in terms of installed capacity. Electrification coverage reached 99.85% of the communes and 98.88% of rural households. EVN provided electricity for nine out of twelve islands, including Ly Son, Phu Quoc, Kien Hai, Phu Quy, Van Don, Co To, Cat Hai, Con Dao and Bach Long Vy, among which Cat Hai, Phu Quoc, Co To, Ly Son and

Kien Hai were connected to the national grid either by submarine cables or overhead lines.

The year 2015 also witnessed great improvements in terms of services provided by EVN to its customers. The Getting Electricity Indicator and Customer Satisfaction Index have been improved; the power system operated more reliably; and power losses reduced significantly. The competitive generation market in Vietnam operated safely in parallel with preparation for introduction of wholesale power market.

As 2016 is the first year of the 5-year plan 2016-2020, EVN is required to make progressive efforts to fulfill its role as a key electricity supplier to the national economy as well as enhance its effectiveness and labor productivity as one of the biggest state-owned utility. The motto chosen for

the year 2016, **“Strengthening Institution and Administration within EVN”**, indicates the same devotion and commitment of the EVN management and staff to serve better for the public interest and society while maintaining the core features of EVN’s long-term culture. These help EVN to build a solid foundation for the successful development of 2016-2020 period.

To inherit and develop the 61-year tradition, EVN is determined to accomplish its set targets to the prosperous development of the country.



Duong Quang Thanh
Chairman of the Board

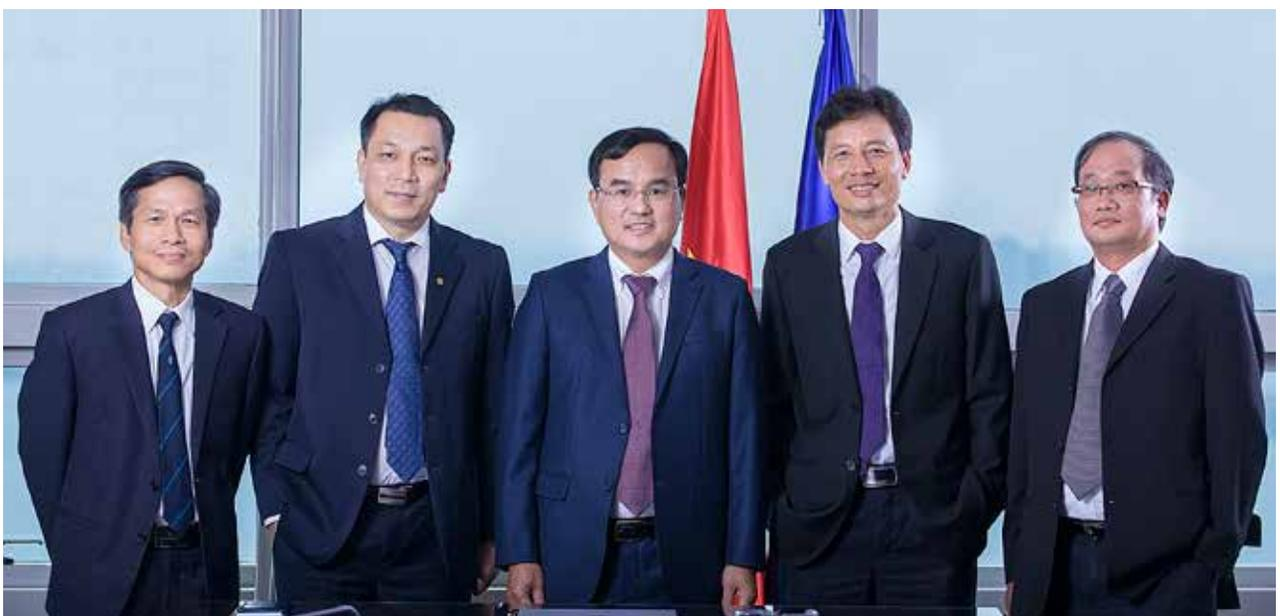



Message from the President and CEO

EVN has specified its targets to meet the power needs of the national economy and society...

The results achieved at the end of 2015 indicated that EVN has accomplished all the targets planned for the period 2011-2015. The most significant achievements are as follows:

- (i) To ensure electricity supply for socio-economic development of the country;
- (ii) To complete a major investment plan for power system expansion;
- (iii) To reach the rural electrification target, with 98.88% rural households electrified;
- (iv) Transmission and distribution losses have been reduced from 10.15% in 2010 to 7.94% in 2015;
- (v) The stability and reliability of electricity supply and customer service quality has tremendously improved;
- (vi) Labor productivity has increased 6.8% per annum;

Beside these, EVN has made remarkable achievements in human resource development, corporate

culture building and public communication.

For the period 2016-2020, EVN has specified its targets to meet the power needs of the national economy and society, to improve the customer services, and to enhance business efficiency, financial viability and labor productivity. Another significant target is to apply modern technology and sophisticated IT structure in power system operation and corporate management.

The upcoming tasks are very challenging but also very exciting and devotion appealing. Stay together and work hard should be the principles and working ethics of each EVN's staff to better serve our beloved country, for better life of Vietnamese citizens.

**Dang Hoang An
President & CEO**

BOARD OF DIRECTORS



Mr. Duong Quang Thanh
Chairman



Mr. Dang Hoang An
*Board Member,
President & CEO*



Mr. Dao Hieu
Board Member



Mr. Mai Quoc Hoi
Board Member



Mr. Pham Manh Thang
Board Member

EXECUTIVE MANAGEMENT



Mr. Dang Hoang An
President & CEO



Mr. Dinh Quang Tri
*Vice President for
economics and finance*



Mr. Nguyen Tan Loc
*Vice President for
power business*



Mr. Nguyen Cuong Lam
*Vice President for
hydropower and
renewable energy
investment*



Mr. Nguyen Tai Anh
*Vice President for
thermal power and
transmission investment*



Mr. Ngo Son Hai
*Vice President for power
system operation and
production*

Organization Chart

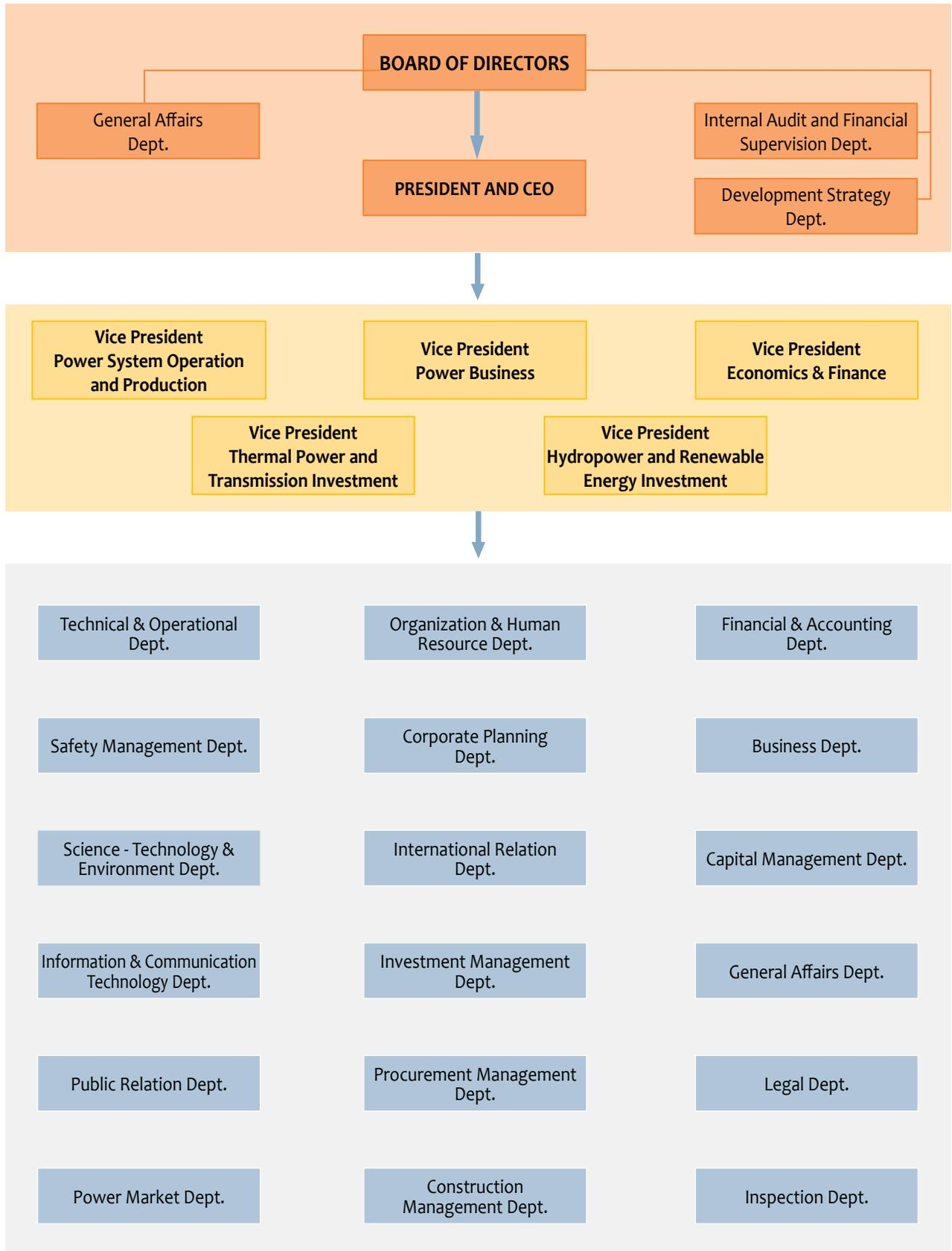



DEPENDENT ACCOUNTING UNITS

1. Hoa Binh Hydropower Company
2. Ialy Hydropower Company
3. Tri An Hydropower Company
4. Tuyen Quang Hydropower Company
5. Se San Hydropower Development Company
6. Son La Hydropower Company
7. Huoi Quang – Ban Chat Hydropower Company
8. Nghi Son 1 Thermal Power Company
9. Hydropower Project Management Board 1
10. Hydropower Project Management Board 4
11. Hydropower Project Management Board 5
12. Hydropower Project Management Board 6
13. Son La Hydropower Project Management Board
14. Ninh Thuan Nuclear Power Project Management Board
15. EVN Construction and Technology Investment Management Board
16. Electric Power Trading Company
17. National Load Dispatch Center
18. Electric Information Center
19. Information and Communications Technology Center of Vietnam Electricity

ONE MEMBER LIMITED LIABILITY COMPANIES

1. Power Generation Corporation 1
2. Power Generation Corporation 2
3. Power Generation Corporation 3
4. National Power Transmission Corporation
5. Northern Power Corporation
6. Central Power Corporation
7. Southern Power Corporation
8. Hanoi Power Corporation
9. Ho Chi Minh City Power Corporation

JOINT STOCK COMPANIES

1. Thu Duc Electrical Mechanical JSC.
2. Dong Anh Electrical Equipment Manufacturing JSC.
3. Power Engineering Consulting 1
4. Power Engineering Consulting 2
5. Power Engineering Consulting 3
6. Power Engineering Consulting 4
7. Vinh Tan 3 Energy JSC.
8. Thuan Binh Wind Power JSC.
9. EVN Finance

Vietnam Electricity Profile



Vietnam Electricity was established by the Government of Vietnam as a State-owned company in 1994, and officially operated as a one-member limited liability company in 2010.

Entrusted with the mission of ensuring sufficient electricity for national socio-economic growth and meeting up with customers' demands with continuously improved quality and services, EVN concentrates on power development and investment while serves the Government as an important macro regulatory instrument for national economic development.

Key business areas of the corporation include power generation, transmission, distribution and sales. EVN contributes up to 61.2% of the national power generation system with large-scale hydropower, coal-fired, gas-fired power plants, with a total installed capacity of 23,580 MW out of 38,553 MW of the national system. EVN owns the entire national

power transmission and distribution system, which covers all provinces and cities, and sells electricity to end-users countrywide.

With three Power Generation Corporations (GENCOs 1,2,3), one power transmission corporation (National Power Transmission Corporation - EVNNPT) and five regional power distribution corporations (for the North, Central, South and the two cities of Hanoi and Ho Chi Minh), and 19 dependent-accounting units, every year EVN continues to exert every effort to ensure adequate power supply for the development of the national economy and society, while effectively manages the operation of the national power system in a safe and reliable manner.

EVN dedicates to the vision of becoming a leading power corporation in the region, playing a key role in ensuring national energy security with high responsibility to the customers and the whole community.



Son La Hydropower Plant

Power Generation



Son La Hydropower Plant

Power generation by ownership as of December 31st, 2015

Owner	Capacity (MW)	Rate (%)
EVN	23,580	61.2%
PetroVietnam	4,435	11.5%
Vinacomin	1,785	4.6%
BOT and other investors	8,753	22.7%
Total	38,553	100%

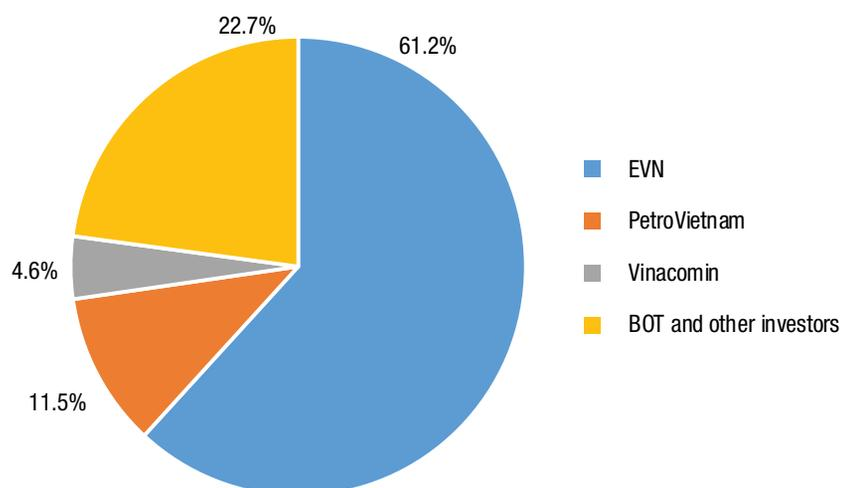



Phu My Power Complex

Power generation by fuel type as of December 31st, 2015

Power source	Capacity (MW)	Rate (%)
Hydropower	14,636	38%
Coal fired power	12,903	33.5%
Oil fired power	875	2.3%
Gas fired power	7,998	20.7%
Renewable	135	0.4%
Diesel and Small hydropower	2,006	5.1%
Total	38,553	100%

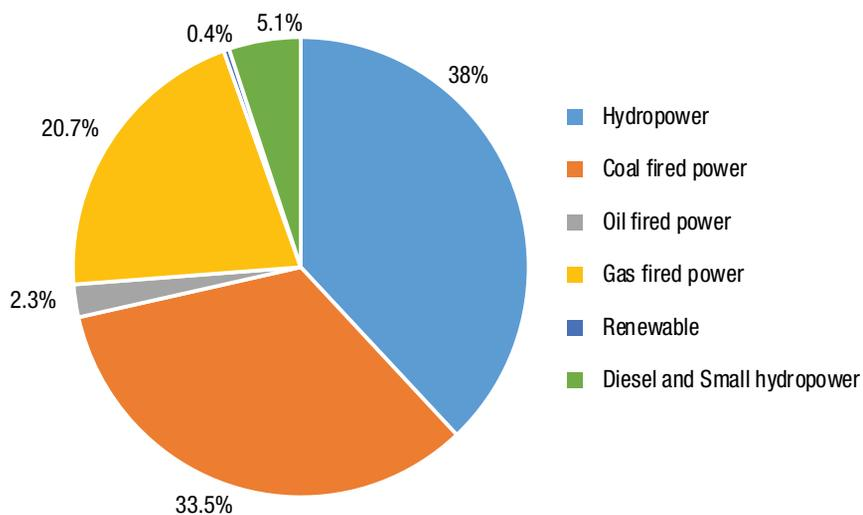

The National Power System

No.	Power plant	Installed capacity
	National system	38,553
A	EVN and GENCOs	23,580
I	EVN' s power plant	7,722
<i>a</i>	<i>Hydropower</i>	<i>7,122</i>
1	Hoa Binh	1,920
2	Son La	2,400
3	Tuyen Quang	342
4	Ialy	720
5	Se San 3	260
6	Pleikrong	100
7	Se San 4	360
8	Tri An	400
9	Ban Chat	220
10	Lai Chau	400
<i>b</i>	<i>Coal fired power</i>	<i>600</i>
1	Nghi Son 1	600
II	GENCO 1	5,144
<i>a</i>	<i>Hydropower</i>	<i>1,965</i>
1	Ban Ve	320
2	Song Tranh 2	190
3	Dai Ninh	300
4	Dong Nai 3	180
5	Dong Nai 4	340
6	Da Nhim	160
7	Ham Thuan	300
8	Da Mi	175
<i>b</i>	<i>Coal fired power</i>	<i>3,179</i>
1	Uong Bi	105
2	Uong Bi Extension 1	300
3	Uong Bi Extension 2	330
4	Quang Ninh 1	600
5	Quang Ninh 2	600
6	Duyen Hai 1	1.244
7	Duyen Hai 3	
III	GENCO 2	4,337
<i>a</i>	<i>Hydropower</i>	<i>973</i>
1	Quang Tri	64
2	Song Ba Ha	220
3	A Vuong	210
4	An Khe - Kanak	173
5	Thac Mo	150

No.	Power plant	Installed capacity
6	Song Bung 4	156
<i>b</i>	<i>Coal fired power</i>	<i>2,240</i>
1	Pha Lai 1	440
2	Pha Lai 2	600
3	Hai Phong 1	600
4	Hai Phong 2	600
<i>c</i>	<i>Oil fired power</i>	<i>200</i>
1	Thu Duc	165
2	Can Tho	35
<i>d</i>	<i>Oil-fired gas turbines</i>	<i>264</i>
1	Thu Duc	114
2	Can Tho	150
<i>e</i>	<i>Gas fired power</i>	<i>660</i>
1	O Mon 1	660
IV	GENCO 3	6,377
<i>a</i>	<i>Hydropower</i>	<i>1,102</i>
1	Buon Kuop	280
2	Buon Tua Srah	86
3	Srepok 3	220
4	Thac Ba	120
5	Vinh Son	66
6	Song Hinh	70
7	Huoi Quang	260
<i>b</i>	<i>Coal fired power</i>	<i>2,424</i>
1	Ninh Binh	100
2	Vinh Tan 2	1,244
3	Mong Duong 1	1,080
<i>c</i>	<i>Gas fired power</i>	<i>2,851</i>
1	Phu My 21	896
2	Phu My 1	1,108
3	Phu My 4	458
4	Ba Ria	389
B	Others	14,973
<i>a</i>	<i>Hydropower (≥30MW)</i>	<i>3,474</i>
1	Cua Dat	97
2	Nam Chien 2	32
3	Thai An	82
4	Su Pan	35
5	Huong Son	33
6	A Luoi	170
7	Bac Ha	90

No.	Power plant	Installed capacity
8	Nho Que 3	110
9	Ba Thuoc	80
10	Muong Hum	32
11	Chiem Hoa	48
12	Ta Co (Nam Cong 2)	30
13	Nam Phang	36
14	Nam Chien 1	200
15	Khe Bo	100
16	Hua Na	180
17	Ta Thang	60
18	Van Chan	57
19	Se San 3A	108
20	Song Con 2	63
21	Srepok 4	80
22	KRong H'Nang	64
23	Huong Dien	81
24	Bac Binh	33
25	Binh Dien	44
26	Za Hung	30
27	Dak Psi 4	30
28	Se San 4A	63
29	Dak R'Tih	144
30	Dak My 4	190
31	Song Bung 5	57
32	Song Bung 4A	49
33	Srepok 4A	64
34	Can Don	78
35	Srokphumieng	51
36	Da Dang	34
37	Dam Bri	75
38	Ngoi Phat	72
39	Song Bac	42
40	Dak Drinh	125
41	Dong Nai 2	70
42	Song Giang	37
43	Nam Pong	32
44	Nam Na 2	44
45	Ngoi Hut 2	48
46	Nam Muc	44
47	Dong Nai 5	150
b	Coal fired power	4,460
1	Na Duong	110

No.	Power plant	Installed capacity
2	Cao Ngan	115
3	Formosa Dong Nai	310
4	Formosa Ha Tinh	150
5	Son Dong	220
6	Cam Pha I	300
7	Cam Pha II	300
8	Mao Khe	440
9	Vung Ang I	1,245
10	Mong Duong 2	1,120
11	An Khanh I	120
12	Nong Son	30
c	Oil fired power	675
1	Cai Lan	39
2	Amata	13
3	Bourbon	24
4	Vedan	72
5	Hiep Phuoc	375
6	Phu My fertilizer	18
7	Dung Quat oil refinery	104
8	Bauxit aluminum factory	30,0
d	Gas fired power	4,223
1	Phu My 3	733
2	Phu My 22	733
3	Ca Mau 1	771
4	Ca Mau 2	771
5	Nhon Trach 1	465
6	Nhon Trach 2	750
e	Wind power	135
1	Tuy Phong	30
2	Phu Quy	6
3	Bac Lieu Wind power - stage 1	16
4	Bac Lieu Wind power - stage 2	83
f	Small hydropower and others (<30MW)	2,006
1	Northern small hydropower	1,008
2	Central small hydropower	787
3	Southern small hydropower	154
4	Gia Lai sugar-cane	12
5	Ayun Pa sugar-cane	20
6	Ninh Hoa baggasse	8
7	Cam Ranh baggasse	11
8	Soc Trang baggasse	6

Power Transmission and Distribution Networks



National Power Transmission Corporation (EVNNPT)

The national power transmission system as of December 31st, 2015

	Unit	Quantity
500kV lines	km	7,183
220kV lines	km	15,079
110kV lines	km	33
500kV transformers	MVA	22,950
220kV transformers	MVA	35,851
110kV transformers	MVA	3,261

Transmission capacity (MW)

Year	North – Central	Central - South
2015	1,800	3,500
2016	2,000	4,000
2017-2020	2,400	4,000

Transmission system expansion

	Unit	2016-2020	2021-2025	2026-2030
500kV substation	MVA	26,700	26,400	23,550
220kV substation	MVA	34,966	33,888	32,750
500kV lines	km	2,746	3,592	3,714
220kV lines	km	7,488	4,076	3,435

Power distribution networks as of December 31st, 2015

	Unit	Quantity
220kV lines	km	108
110kV lines	km	18,681
Medium and low voltage lines	km	476,572
220kV transformers	MVA	2,250
110kV transformers	MVA	42,332
Medium and low voltage transformers	MVA	81,141

Northern Power Corporation (EVNNPC)

	Unit	Quantity
110kV lines	km	8,990
Medium and low voltage lines	km	205,478
220kV transformers	MVA	250
110kV transformers	MVA	15,618
Medium and low voltage transformers	MVA	23,914

Central Power Corporation (EVNCPC)

	Unit	Quantity
110kV lines	km	3,331
Medium and low voltage lines	km	68,566
110kV transformers	MVA	4,264
Medium and low voltage transformers	MVA	8,544

Southern Power Corporation (EVNSPC)

	Unit	Quantity
110kV lines	km	4,955
Medium and low voltage lines	km	147,963
110kV transformers	MVA	12,120
Medium and low voltage transformers	MVA	26,530

Hanoi Power Corporation (EVNHANOI)

	Unit	Quantity
220kV lines	km	8
110kV lines	km	720
Medium and low voltage lines	km	36,465
220kV transformers	MVA	250
110kV transformers	MVA	4,228
Medium and low voltage transformers	MVA	11,365



Ho Chi Minh City Power Corporation (EVNHCMC)

	Unit	Quantity
220kV lines	km	100
110kV lines	km	685
Medium and low voltage lines	km	18,100
220kV transformers	MVA	1,750
110kV transformers	MVA	6,102
Medium and low voltage transformers	MVA	10,788

Performance Highlights



Provided sufficient electricity for the national socio-economy development and secured efficient operation of the national power system in a safe and stable manner, with high reliability and quality of power supply

In 2015, Vietnam Electricity, playing its leading role in the energy sector, ensured adequate power supply for the national socio-economic development as assigned by the Government. Total power production and purchase by EVN reached 159.68 billion kWh, a surplus of 2.78 billion kWh over the set target. Power supply and demand were managed upon appropriate mobilization of power sources, ensuring safe and reliable operation of the entire power system with a reserved capacity of more than 20%.

By the end of 2015, EVN has provided electricity to 23.68 million customers, marking an increase of 6.2 million compared to 2010. Average electricity consumption per capita reached 1,565kWh, which was 1.6 times higher compared to 2010. Electrification of rural areas and remote islands was ahead of the plan. With 99.85% of communes and 98.88% of households connected to electricity, EVN made a significant contribution to the national programs of hunger elimination and poverty reduction.

Rural electrification

Year	2010	2011	2012	2013	2014	2015
Communes	98.63%	98.72%	99.36%	99.57%	99.70%	99.85%
Rural households	95.97%	96.65%	97.19%	97.85%	98.05%	98.88%





Investment and construction of power generation and network projects outperformed targets assigned by the Prime Minister. Many power projects were completed in time and put into operation with high efficiency, adding 3,314 MW of new installed capacity to the power system. By the end of 2015, EVN owned 23,580 MW installed capacity out of the

total system of 38,553MW. Besides, the national grid was expanded with 12,290 MVA of new capacity and 2,980 km of transmission line. EVN's transmission and distribution networks currently cover 41,084 km of 500-220-110kV and 476,572 km of medium and low voltage lines. Total power substation capacity increased 1.8 times compared to 2010.

Completed major investment plan for expansion of power generation and network system

Duyen Hai Thermal Power Complex



Successfully undertook motto of the year 2015 as “Productivity and Efficiency”, obtaining continuous enhancement in power sales and customer services

In 2015, average electricity tariff of EVN stayed at about US cent 7.38/kWh. *System Average Interruption Duration Index (SAIDI)* decreased to 2,281 minutes per customer, down 27% from 2014. *System Average Interruption Frequency Index*

(SAIFI) reduced to 13.36 times per customer, down 26% from 2014. *Momentary Average Interruption Frequency Index (MAIFI)* was kept at 2.03 times per customer, down 23% from 2014. Power losses of the entire power system fell to 7.94%.

SAIDI
(minutes per customer)

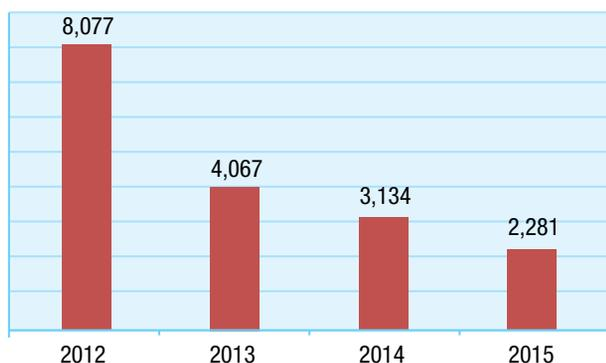

SAIFI
(times per customer)



MAIFI
(times per customer)

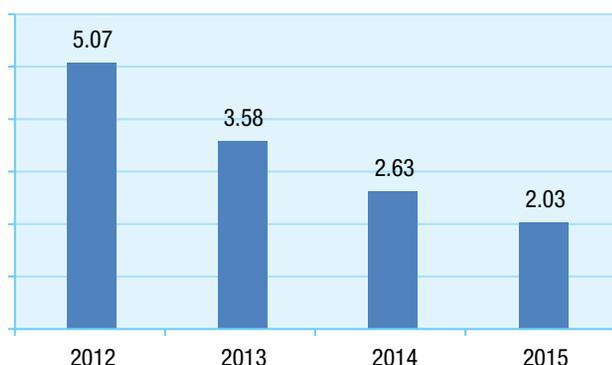

Power losses

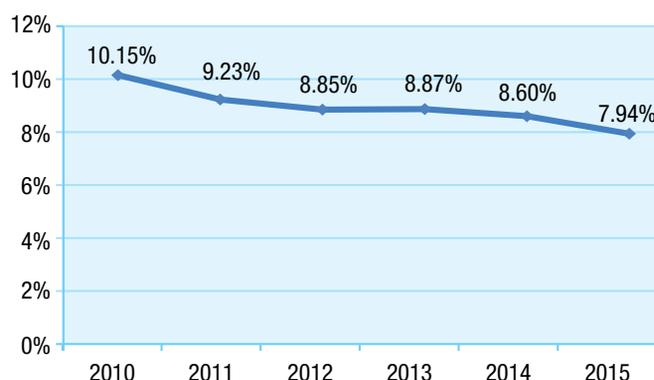

Following the motto of 2015 - “Productivity and Efficiency” - EVN achieved a 10% increase in productivity of power production and sales over 2014, reaching 1.54 million kWh per employee. Customer services quality has also been improved tremendously. According to the evaluation report

by the World Bank (<http://www.doingbusiness.org/rankings>, as of June 2016), Vietnam’s Getting Electricity Indicator was up 34 steps (from 130 in 2014 to 96 over 190 nations), which was the best improvement compared other indicators in Vietnam’s investment and business environment.



Power Business and Services



Power production by fuel type

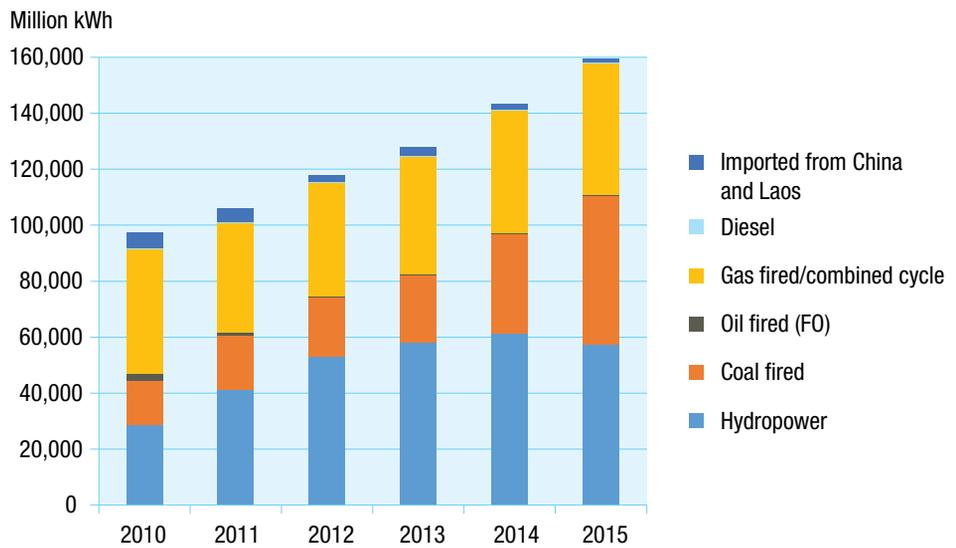

Power production by EVN & GENCOs in 2015

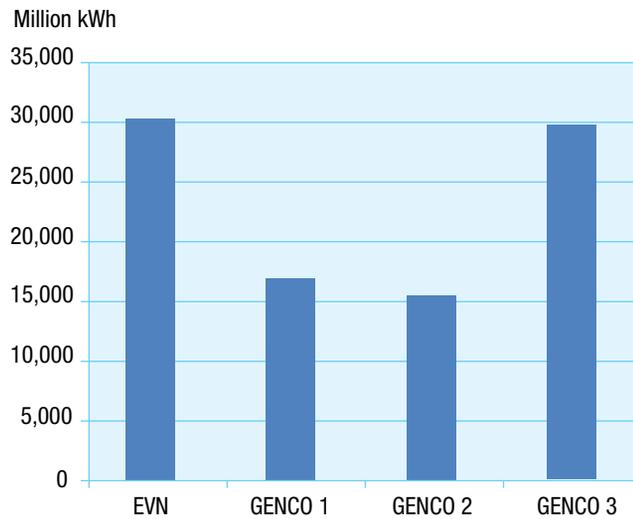



Ha Long city

Power sales by power utility

Years	2010	2011	2012	2013	2014	2015
Power Sales (mil. kWh)	85,669	94,657	105,474	115,283	128,628	143,682
EVN <i>NPC</i>	23,848	27,082	30,105	33,579	39,153	44,778
EVN <i>SPC</i>	28,867	32,307	36,290	39,980	44,596	49,387
EVN <i>CPC</i>	8,293	9,063	10,275	10,954	12,221	13,569
EVN <i>HANOI</i>	8,896	9,514	10,588	11,283	12,562	14,137
EVN <i>HCMC</i>	14,614	15,314	16,725	17,651	18,608	20,182

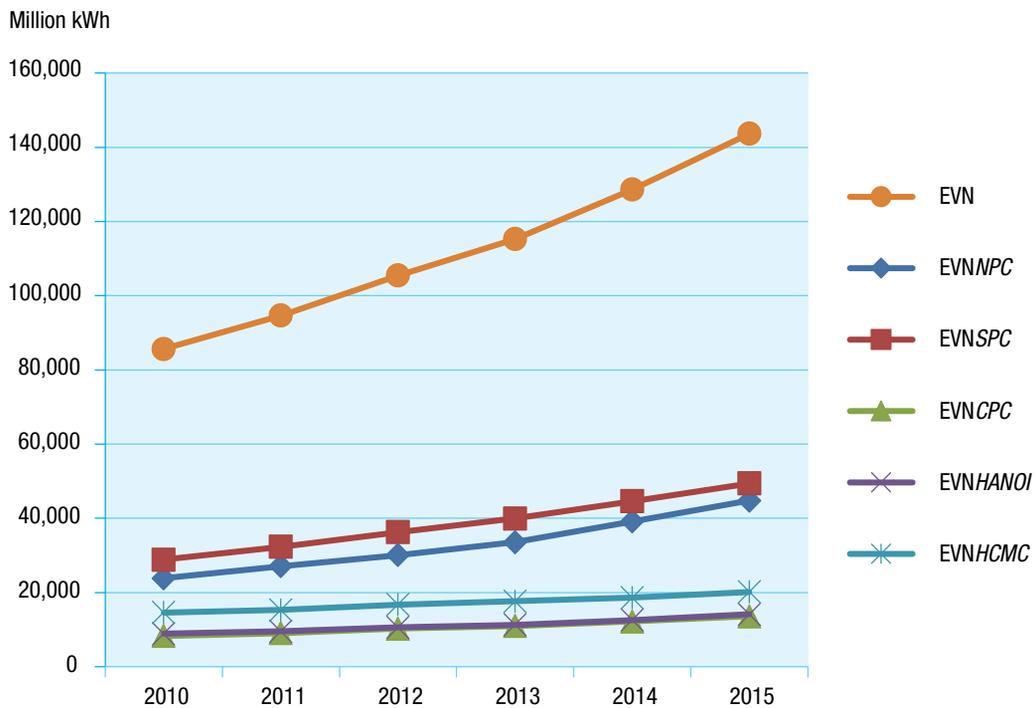



Power sales by customer type

Years	2010	2011	2012	2013	2014	2015
Power Sales (mil. kWh)	85,669	94,657	105,474	115,283	128,628	143,682
Agriculture, Forestry and Aquaculture	947	1,079	1,266	1,502	1,892	2,327
Industry and Construction	44,668	50,328	55,568	61,277	69,524	77,189
Commercial & Hotels, Banks	3,896	4,334	4,988	5,374	6,131	7,548
Administration & Residential	31,971	34,212	38,421	41,483	45,468	50,377
Others	4,187	4,704	5,232	5,647	5,612	6,242

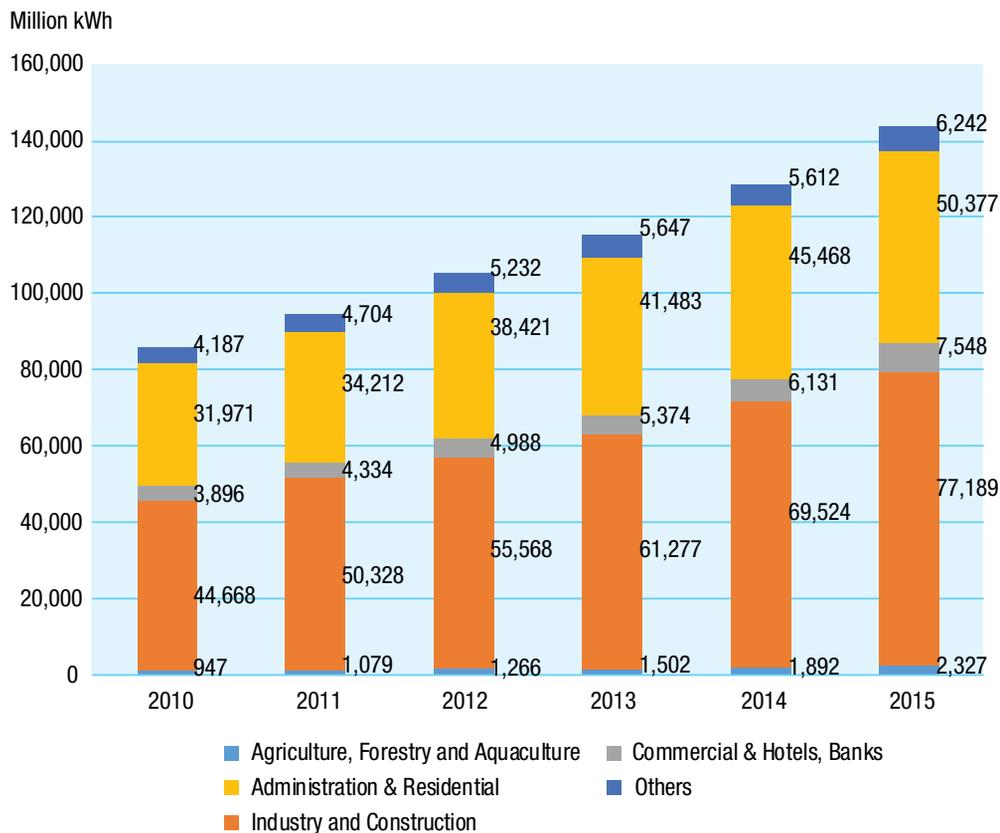

Power sales growth

Years	2010	2011	2012	2013	2014	2015
Power sales growth	14.50%	10.49%	11.43%	9.30%	11.58%	11.70%



Power import

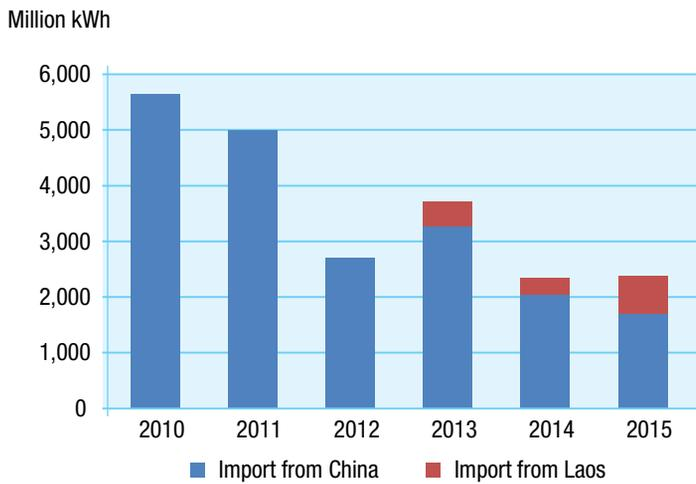

Power export

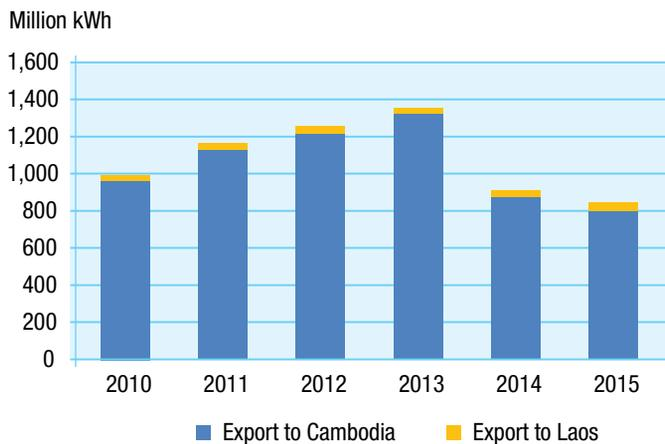

Consolidated Financial Statements



Consolidated Financial Statements

Millions of VND

	2014	2015
1. Total revenue	202,648,668	240,735,176
2. Less	3,667	1,264
3. Net sales	202,644,991	240,733,912
4. Cost of goods sold	173,283,014	204,486,241
5. Gross profit	29,361,977	36,247,671
6. Revenue from financial activities	5,693,342	2,107,064
7. Financial activities expenses	17,604,425	19,563,128
8. Selling expenses	4,403,184	5,237,475
9. Overhead expenses	8,159,122	9,440,746
10. Net profit from operations	5,292,492	4,424,901
11. Other incomes	751,653	666,841
12. Other expenses	692,662	496,560
13. Other profit	58,991	170,281
14. Profit (loss) in affiliates	403,904	311,515
15. Gross profit before tax	5,351,483	4,595,182
16. Current corporate income tax	1,181,893	985,587
17. Deferred corporate income tax	-75,902	-89,647
18. Profit after tax	4,245,492	3,699,242
18.1. Profit of minority shareholders	912,902	142,341
18.2. Profit of majority shareholders	3,332,590	3,556,901



Sapa Town

Consolidated Balance Sheets

Millions of VND

	2014	2015
ASSETS		
A. Current assets	99,174,458	105,607,929
I. Cash and cash equivalent	44,325,289	41,968,868
II. Short-term investment in securities	9,979,837	17,360,700
III. Short-term receivables	24,138,513	24,288,899
IV. Inventories	15,999,249	17,063,073
V. Other current assets	4,731,571	4,926,389
B. Non-current assets	476,913,848	535,432,761
I. Long-term receivables	2,351,294	1,497,334
II. Fixed assets	321,772,214	425,426,007
III. Real assets investment	1,257	1,192
IV. Long-term financial investments	6,142,879	5,032,379
V. Other non-current assets	2,959,429	3,459,048
Total assets	576,088,306	641,040,690
EQUITY AND LIABILITIES		
A. Liabilities	407,119,866	454,760,498
I. Current liabilities	103,443,435	120,237,063
II. Non-current liabilities	303,676,431	334,523,436
B. Owner's equity	168,968,440	186,280,192
I. Owner's equity	168,952,899	186,308,318
II. Other funds	15,541	-28,126
Total equity and liabilities	576,088,306	641,040,690

International Cooperation and Investment Opportunities



INTERNATIONAL COOPERATION

In 2015, while securing sufficient investment funding for power projects continues to be a challenge for Vietnam Electricity, total amount of Official Development Assistance (ODA) and foreign concessional loans pledged by international financial institutions reached USD 2.8 billion for power projects implemented in the period 2015-2017, of which USD 785 million was finalized and came into effect.

In power exchange between neighboring countries in the period 2011-2015, EVN imported 14.7 billion kWh from China and 1.414 billion kWh from Laos and exported more than 7.2 billion kWh to Cambodia, and nearly 190 million kWh to Lao PDR.

Under ASEAN cooperation program in energy sector, EVN played an active role in the Forum of the Heads of ASEAN Power

Utilities Authorities (HAPUA). Besides, EVN took place in various activities of Association of the Electricity Supply Industry of East Asia and the Western Pacific (AESIEAP), General Planning Managers of Northeast and Southeast Asian Electric utilities (GPM) and Asia-Pacific Economic Cooperation (APEC) as well as other exchange activities as part of its integration into the region and the world.

INVESTMENT OPPORTUNITIES

According to the revised Power Development Master Plan for the period 2011-2020 with an outlook to 2030 approved by the Government of Vietnam, EVN needs a huge annual investment of about USD 5 billion for power project development. In coming years, new power generation projects applying advanced technologies of coal-fired, gas-fired, renewable energy etc., as well as transmission and distribution

projects are scheduled to start construction. In addition to that, EVN needs to import primary fuel such as coal and considers importing LNG for reliable and economic operation of its power plants.

For future development, EVN encourages cooperation with foreign partners in manufacturing and supplying equipment, repair and maintenance services for

power plants and grids, conducting research and development on new technologies of smart grid and renewable energy.

To explore financial sources and invest in new power projects, EVN invites participation in equitization process of power generation corporations (GENCOs) and welcomes new participants of the power market in Vietnam.



Lai Chau Hydro Power Plant



Investment Projects

Power generation projects put into operation in the period 2016-2020

No.	Project	Capacity (MW)	Owner
I	2016	2,434	
1	Huoi Quang HPP (unit 2)	1x260	EVN
2	Lai Chau HPP (units 2,3)	2x400	EVN
3	Trung Son HPP (units 1,2)	2x65	GENCO 2
4	Duyen Hai 3 TPP	2x 622	GENCO 1
II	2017	1,505	
1	Trung Son HPP (units 3,4)	2x65	GENCO 2
2	Song Bung 2 (units 1,2)	2x50	GENCO 2
3	Thac Mo Extension HPP	1x75	EVN
4	Thai Binh TPP (units 1,2)	2x300	EVN
5	Vinh Tan 4 TPP (unit 1)	1x600	EVN
III	2018	1,340	
1	Vinh Tan 4 TPP (unit 2)	1x600	EVN
2	Da Nhim Extension HPP	80	DHD JSC
3	Duyen Hai 3 Extension TPP	1x660	EVN
IV	2019	820	
1	Upper Kon Tum HPP (units 1,2)	2x110	VSH JSC
2	Vinh Tan 4 Extension TPP	1x600	EVN
V	2020	1,110	
1	O Mon 3 TPP	750	EVN/GENCO 2
2	Ialy Extension HPP (units 1,2)	2x180	EVN

Power generation projects to commence construction in the period 2016-2020

No.	Project	Capacity (MW)	Construction time
I	2016	600	
1	Vinh Tan 4 Extension TPP	600	2016-2019
II	2018	4,190	
1	Ialy Extension HPP	2x180	2018-2021
2	Hoa Binh Extension HPP	2x240	2018-2021
3	Tri An Extension HPP	2x100	2018-2021
4	O Mon 3 TPP	750	2018-2021
5	Bac Ai PSPP	4x300	2018-2023/2025
6	Quang Trach 1 TPP	2x600	2018-2021/2022
III	2019	750	
1	O Mon 4 TPP	750	2019-2022
IV	2020	3,200	
1	Quang Trach 2 TPP	2x600	2020-2023/2024
2	Tan Phuoc 1& 2 TPP	2x1000	2020-2023/2024
	Total	8,740	

500kV network projects put into operation in the period 2016-2020

No.	Project	Length (km)	Capacity (MVA)
I	2016		
1	500kV Pho Noi substation and connections	2&4x1.23 +10.03	600
2	500/220kV Hiep Hoa - Dong Anh - Bac Ninh 2 transmission lines	1x43 (500kV) +2x43+ 4x6	
3	500kV Dong Anh substation	2x1.675	900
4	Upgrading capacity of 500kV Son La substation		2x900
5	Expansion of 500kV Quang Ninh substation and 500kV Hiep Hoa substation to connect with 500kV Quang Ninh-Hiep Hoa transmission lines (circuit 2)		
6	500kV Pleiku 2 substation		
7	500/220kV transformer for 500kV Pleiku 2 substation	2x3.8	2x450
8	500kV My Tho substation and connections	2 x 1.55+ 2 x 2.54	900
9	500kV Duyen Hai TPP - My Tho transmission lines	2x113	
10	Connecting Vinh Tan 4 TPP to National Power Grid	2x1.864	

500kV network projects put into operation in the period 2016-2020 (continued)

No.	Project	Length (km)	Capacity (MVA)
II	2017		
1	500kV transmission line connecting Thang Long TPP	2x4.039	
2	500kV Western Ha Noi substation		900
3	500kV Viet Tri substation and connections	2x2.5+4x16	450+900 (Phase 1: 450)
4	500kV Lai Chau substation	2x1.547	2x450+2x250 (Phase 1: 450+250)
5	Upgrading capacity of the 2 nd 500kV transformer for Thuong Tin substation		900
6	The 2 nd 500kV transformer for 500kV Pho Noi substation		900
7	Upgrading capacity of 500kV Quang Ninh substation		2x600
8	Upgrading capacity of 500kV Tan Dinh substation		900
9	The 2 nd 500kV transformer for Cau Bong substation		900
10	500kV Long Phu TPP - O Mon transmission lines	2x85.2	
11	500kV Tan Uyen substation	4x 12.79	900+250
12	500kV Song May - Tan Uyen transmission lines	2x7.84 + 4x15.48	
III	2018		
1	500/220kV Nho Quan - Phu Ly - Thuong Tin transmission lines	6&3&2& 1x3.9+39.23+2.646+32	
2	500kV Western Ha Noi - Thuong Tin transmission lines	2x39.97	
3	The 2 nd transformer for 500kV Dong Anh substation		900
4	Vinh Tan - branch to Song May - branch to Tan Uyen transmission lines	2 x233.84	
5	500kV Chon Thanh (My Phuoc) substation		1x900 + 1x250
6	500kV Duc Hoa - Chon Thanh transmission lines	2x104	
7	500kV Duc Hoa substation and connections	2x12.4 + 4x24.4 +4x29.8	900
8	500kV My Tho - Duc Hoa transmission lines	2x60	
9	500kV Song Hau - Duc Hoa transmission lines	2x138	
10	The 2 nd 500kV transformer for My Tho substation		900
IV	2019		
1	500kV Cong Thanh - Nghi Son transmission line	18	
2	500kV transmission line connecting Nghi Son 2 TPP to the national power grid	4x50	
3	The 2 nd 500kV transformer for Tan Uyen substation		900

No.	Project	Length (km)	Capacity (MVA)
V	2020		
1	500kV Nam Dinh 1 TPP - Pho Noi transmission lines	2x133	
2	The 2 nd 500kV transformer for Lai Chau substation		450
3	500kV Vung Ang - Branch to Ha Tinh - Da Nang transmission lines (circuits 3,4)	2x16	
4	Quang Trach TPP - Vung Ang transmission lines	2x18	
5	500kV Binh Duong 1 substation		
6	500kV Long Thanh substation		900
7	500kV Long Thanh - Phu My - branch to Song May transmission lines	2x16	
8	Upgrading 500kV Nha Be substation		2x900
9	500kV Cu Chi substation and connections	2x20	900
10	Upgrading capacity of the 2 nd 500kV transformer for Tan Dinh substation		900
11	Upgrading capacity of the 2 nd 500kV transformer for O Mon substation		900





Renewable Energy Development and Environmental Protection

Nowadays, the Government of Vietnam encourages clean energy development in an effort to fulfill obligations and commitments under the United Nation Framework Convention on Climate Change (UNFCCC) and Paris COP21 agreement, continuing to implement the national strategy, programs, and plans in response to climate change.

According to Prime Minister's Decision No.2068/QĐ-TTg on approving Vietnam's Strategy on renewable energy development up to 2020, with a vision towards 2050 dated November 25, 2015, renewable energy rate in the total primary energy consumption in 2015 is expected to reach approximately 31.8%, about 31% in 2020, about 32.3% in 2030 and increase to 44% in 2050. As projected in the revised Master plan for National power development for the period 2015-2020 with an outlook to 2030 approved by the government, there will be 2060 MW of renewable energy capacity

to put into operation during the period of 2016 to 2020; 5990 MW during 2021-2025, and 15190 MW during 2026-2030. In line with this ambitious development plan, EVN has been studying the feasibility of developments and investments in renewable energy, focusing on wind and solar power projects.

In September 2016, the first Phu Lac 1 wind power project, with a capacity of 24 MW, was put into operation by Thuan Binh wind power joint-stock company (A company in which EVN and its member companies hold 75% of the shares), using ODA loan from German Government. The next wind power project of Loi Hai 2, located in Ninh Thuan province with a capacity of 30MW, is registered for ODA financing from German bank of KfW. Currently, EVN prepares for investment in new Phuoc Thai solar farm project, located in Ninh Thuan province with a total capacity of 200MW, and considers potential floating PV projects on

reservoirs of existing hydropower plants.

Going green for stable development of a clean power generation source, EVN's objective is to increase the proportion of renewable energy in power production and consumption, to reduce the dependence on fossil fuel, and to assure energy security, decrease environment pollution as well as mitigate the effects of climate change and global warming.

Being committed to green development, EVN is determined to take the lead and set a good example in environmental protection. In this endeavor, EVN and all its member companies are required to strictly comply with the Law on Environmental Protection and follow related legal documents, to concentrate necessary capable human and financial resources on environmental measures, and to properly monitor and control environmental protection activities of every company within EVN.



Power Market Development

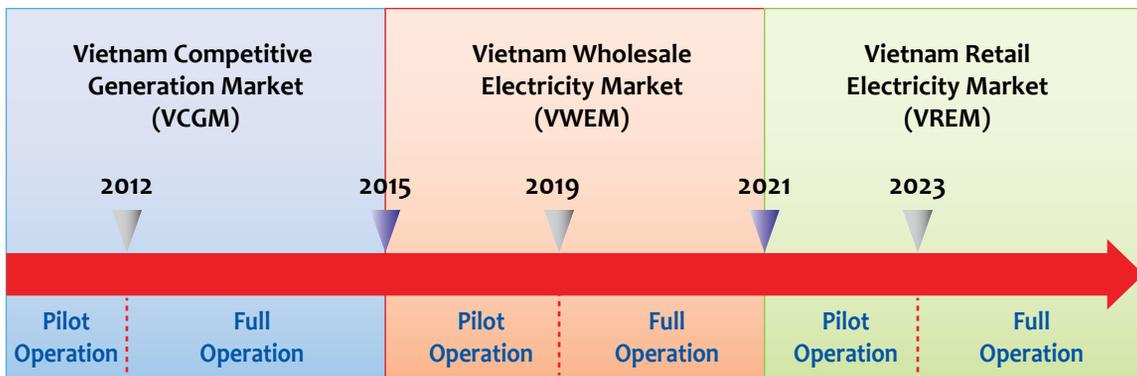

According to the Prime Minister's Decision No. 63/2013/QĐ-TTg dated November 8, 2013 on the roadmaps, conditions and sector structure for establishment and development of power market stages in Vietnam, Vietnam power market would be formed and developed through three grades:

- Competitive power generation market: Accordingly, the competitive power generation was completed by the end of 2014.
- Competitive wholesale market: To be implemented in two phases as pilot wholesale market in 2015-2016, and full competitive wholesale

market from 2017 to 2021. Competitive electricity retail market: To be introduced as pilot retail market in 2022-2023, and full competitive retail market from 2024 forward.

Since the introduction of Vietnam Competitive Generation Market (VCGM) in 2012 till 2015, the power market had been successfully operated, laying a crucial foundation for the second phase of Vietnam Wholesale Electricity Market (VWEM). For the period of 2016 to 2020, EVN was assigned by the Government to build a modern and integrated information

technology infrastructure and training human resources, ready for the operation of wholesale competitive market in the coming years.

Vietnam power market is operated in accordance with the regulations issued by the Ministry of Industry and Trade. As of December 31st, 2015, 63 power plants directly participated in the power market with total installed capacity of 15,111 MW, accounting for 41% of the national system (including power plants with capacity over 30MW). Since its operation from July 2012, Vietnam power system has been operating in a safe and stable manner.



VWEM PARTICIPANT AND STRUCTURE

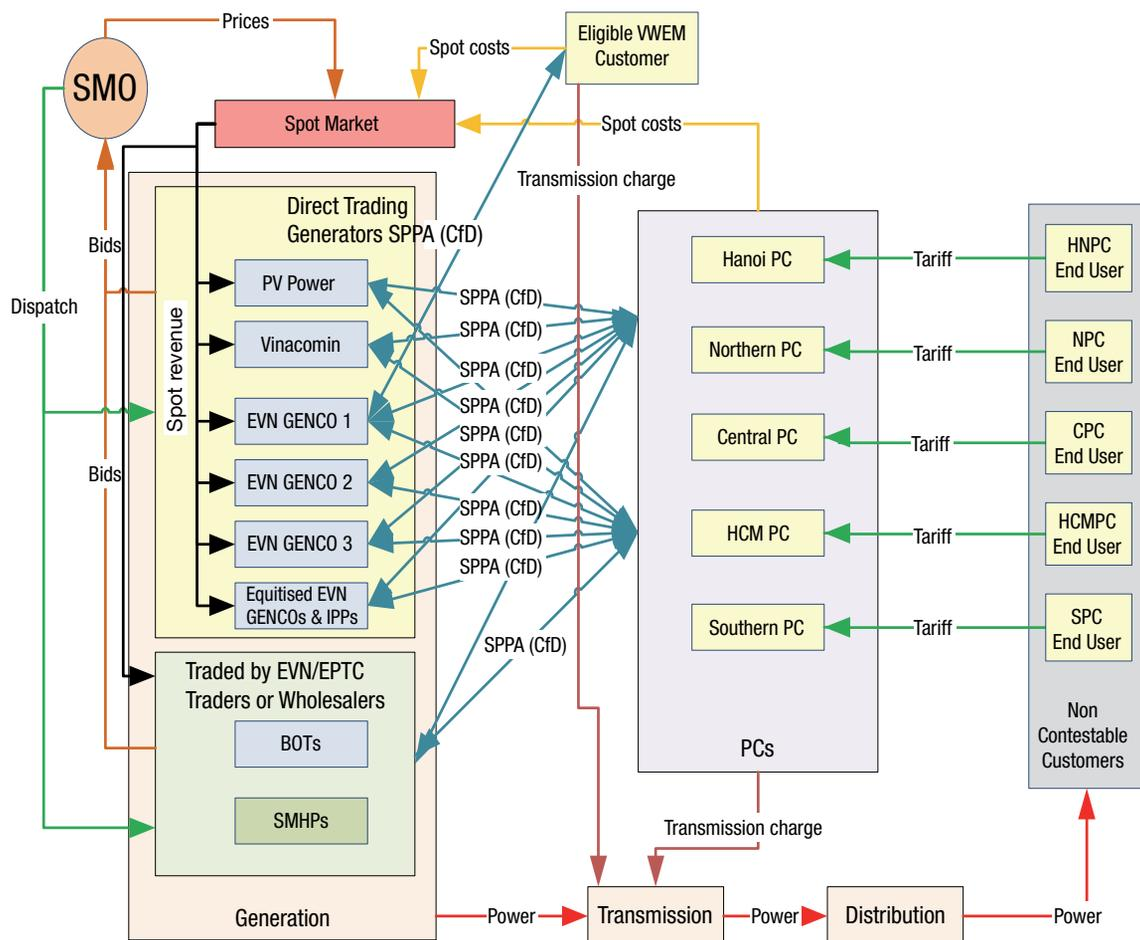

NLDC: National Load Dispatch Center

<p>Trading generators (directly)</p> <ul style="list-style-type: none"> - GENCOs, IPPs - BOT, SMHP 	<p>Service providers:</p> <ul style="list-style-type: none"> - NLDC/SMO: System Operator and Market Operation - NPT: Transmission Operator - Distribution utility: Provide the distribution MDMSP: Metering Data Management Service Provider 	<p>Wholesale buyer units:</p> <p>PCs: Wholesale buyer and sell to end user</p> <p>Big customer</p>	<p>EPTC</p> <p>Buy electricity from generators do not participate in electricity market and sells to PCs</p>
--	--	--	--

Training and Human Resource Development



In 2015, various important training programs were conducted by EVN, including domestic and overseas, long-term and short-term courses for both technical experts and management personnel in order to meet up with new development requirements of the corporation.

EVN paid due attention to technical training, aiming at building a professional and highly skilled technical team responsible for complex tasks, typically in the areas of emergency repair, smart grid development, power system stability and over voltage recovery calculation, control and protection system, primary equipment (circuit breaker, transformer) for power transmission network, AVR system, Simadyn D system in gas turbine power plants, dynamic balancing, and boiler drum level control for thermal power plants, etc. Besides, management

training courses were designed and conducted appropriately for different management levels of highly qualified managers with advanced business administration and management skills.

In preparation for operation of large power plant projects, EVN focuses on training operation teams to be fully capable in operating power plants safely and efficiently.

In the forthcoming time, aiming at building business administration capacity and improving business performance and labor productivity, EVN gives priority to the development of highly qualified human resources in order to understand and control transferred advanced technologies, and to become more experienced in power sector reform by learning from developed countries in the region and the world.



Member Companies



Dependent-accounting units

No.	Company	Address	Phone	Fax
Power Generation				
1	Hoa Binh Hydropower Company	428 Hoa Binh road, Tan Thinh ward, Hoa Binh city, Hoa Binh province	0218 3852043	0218 3854155
2	Ialy Hydropower Company	727 Pham Van Dong street, Pleiku city, Gia Lai province	059 2222008	059 3866470
3	Tri An Hydropower Company	Vinh An Town, Vinh Cuu district, Dong Nai province	061 2217929	061 3861257
4	Tuyen Quang Hydropower Company	403 Truong Chinh street, Y La ward, Tuyen Quang city, Tuyen Quang province	027 3980929	027 3980919
5	Se San Hydropower Development Company	114 Le Duan road, Pleiku city, Gia Lai province	059 3514118	059 2222369/ 059 3877279
6	Son La Hydropower Company	56 Lo Van Gia street, Chieng La district, Son La city, Son La province	022 2240030/ 022 2211132	022 3751106/ 022 3830605
7	Huoi Quang – Ban Chat Hydropower Company	Na Khiet village , Muong Cang commune, Than Uyen town, Than Uyen district, Lai Chau province	0231 2489565	0231 3783579
8	Nghi Son 1 Thermal Power Company	Km 11, road 513, Hai Ha commune, Tinh Gia district, Thanh Hoa province	037 3613456	037 3613333
9	Hydropower Project Management Board 1	Floor 8, Tower B, EVN Building, No 11 Cua Bac street, Hanoi	04 66941001	04 66941002
10	Hydropower Project Management Board 4	114 Le Duan road, Pleiku city, Gia Lai province	059 3822961/ 059 2222565	059 3874880/ 059 2222569
11	Hydropower Project Management Board 5	25 Truong Chinh street, Buon Ma Thuot city, Dak Lak province	0500 3955584/ 0500 3955581	0500 3955582
12	Hydropower Project Management Board 6	25, Thach Thi Thanh street, Tan Dinh ward, 1 district, Ho Chi Minh city	0822100423	0838206776
13	Son La Hydropower Project Management Board	Floor 6-7, Tower B, EVN Building, 11 Cua Bac street, Hanoi	04 22148183	04 35541371
14	Ninh Thuan Nuclear Power Project Management Board	16/4 street, Phan Rang city, Thap Cham, Ninh Thuan province Floor 15, Tower A - EVN Block, 11, Cua Bac street, Hanoi	068 222310 04 66946764	068 3922991 04 37842781

Service				
15	EVN Construction and Technology Investment Management Board	Floor 4, Tower B, EVN Building, 11 Cua Bac street, Ha Noi	04 66946650	04 37162789
16	Electric Power Trading Company	Floor 12-14, Tower A, EVN Building, 11 Cua Bac street, Ha Noi	04 22218219	04 22218214
17	National Load Dispatch Centre	Floor 8-11, Tower A, EVN Building, 11 Cua Bac street, Ha Noi	04 39276180/ 04 39276178	04 39276181
18	Electric Information Centre	Floor 15, Tower A, EVN Building, 11 Cua Bac street, Ha Noi	04 66946700	04 37725192
19	Information and Communications Technology Center of Vietnam Electricity	Floor 16-18, Tower A, EVN Building, 11 Cua Bac street, Ha Noi	04 22225210	04 22225211

Independent accounting units

No.	Company	Address	Phone	Fax
One member limited liability companies				
1	Power Generation Corporation 1	Quang Trung ward, Uong Bi city, Quang Ninh province	033 3854284	033 3854181
2	Power Generation Corporation 2	1 Le Hong Phong street, Binh Thuy ward, Can Tho city	0710 2461507/ 0710 6517196	0710 2227446/ 0710 2227447
3	Power Generation Corporation 3	Phu My town, Tan Thanh district, Ba Ria – Vung Tau province	064 3876927	064 3876930
4	National Power Transmission Corporation	18 Tran Nguyen Han street, Hoan Kiem District, Ha Noi	04 22204444	04 22204455
5	Northern Power Corporation	Floor 20-29, Tower B, EVN Building, 11 Cua Bac street, Ha Noi	04 22100705	04 38244033
6	Central Power Corporation	78A Duy Tan Street, Hai Chau district, Da Nang city	0511 2221028	0511 3625071
7	Southern Power Corporation	72 Hai Ba Trung street, district 1, Ho Chi Minh city	08 38221605	08 38221751
8	Ha Noi Power Corporation	69 Dinh Tien Hoang street, Hoan Kiem district, Ha Noi	04 22200898	04 22200899
9	Ho Chi Minh City Power Corporation	35 Ton Duc Thang, Ben Nghe ward, district 1, Ho Chi Minh city	08 22201177	08 22201155
Joint Stock Companies				
1	Thu Duc Electrical Mechanical Joint Stock Company	Km 9 Ha Noi highway, Thu Duc district, Ho Chi Minh city	08 22144647	08 38963159
2	Dong Anh Electrical Equipment Manufacturing Joint Stock Corporation	Team 26, Dong Anh town, Ha Noi	04 38833779	04 38833133
3	Power Engineering Consulting Joint Stock Company 1	Km 9 + 200, Nguyen Trai road, Thanh Xuan district, Ha Noi	04 38544270	04 38541208
4	Power Engineering Consulting Joint Stock Company 2	32 Ngo Thoi Nham street, ward 7, district 3, Ho Chi Minh city	08 22216468	08 22210408/ 08 22210571
5	Power Engineering Consulting Joint Stock Company 3	32 Ngo Thoi Nham street, ward 7, district 3, Ho Chi Minh city	08 22211169	08 39307938
6	Power Engineering Consulting Joint Stock Company 4	11 Hoang Hoa Tham street, Nha Trang city, Khanh Hoa province	058 2220401	058 3824208
7	Vinh Tan 3 Energy JSC	Floor 8, V buiding, 125-127 Ba Trieu street, Ha Ba Trung district, Ha Noi	0439748320	0439748321
8	Thuan Binh Wind Power JSC	Lac Tri village, Phu Lac commune, Tuy Phong district, Binh Thuan province	0623 822 024	0623 823 024
9	EVN Finance JSC	Floor 14-16, Tower B, EVN Building, 11 Cua Bac street, Ha Noi	04 22229999	04 22221999

Geographical Scheme of Vietnam Power System

